

Instrument Panel Center Accessory Function Switch Replacement (WT)

[Removal Procedure](#)

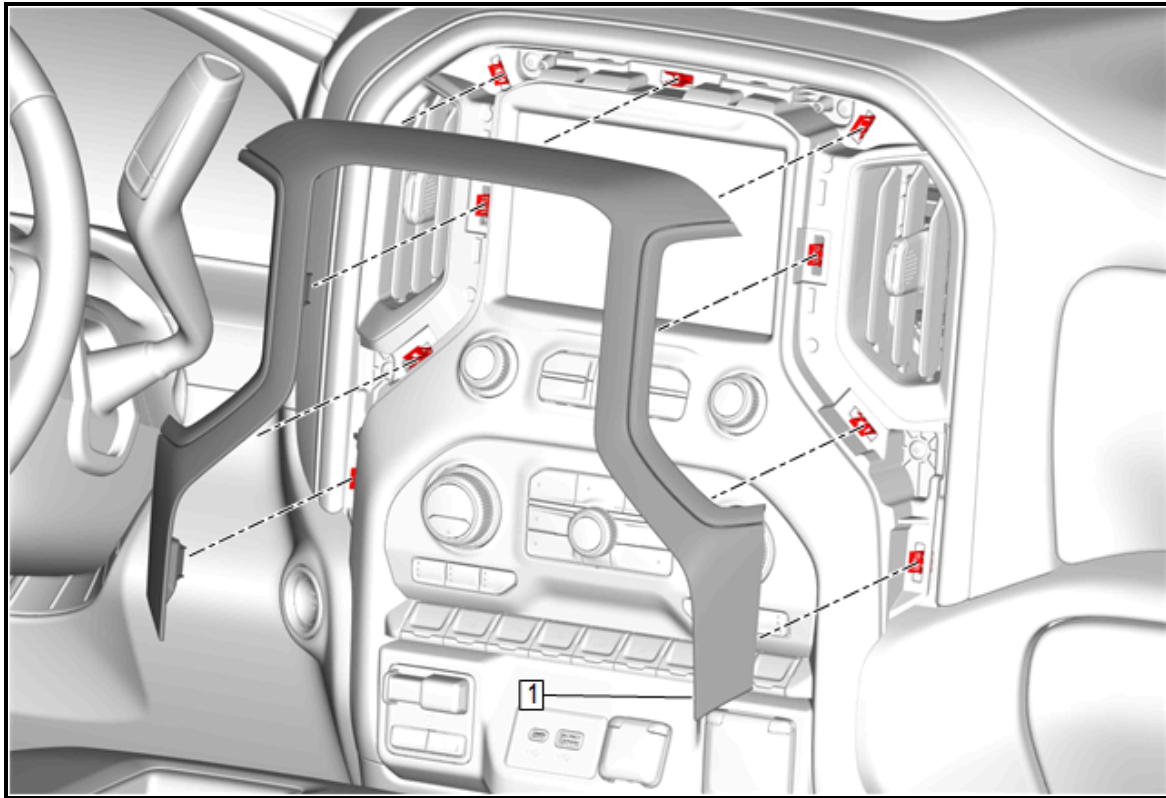

1. Using a flat-bladed plastic trim tool, release the retaining clips.
2. Instrument Panel Trim Plate (1) » Remove

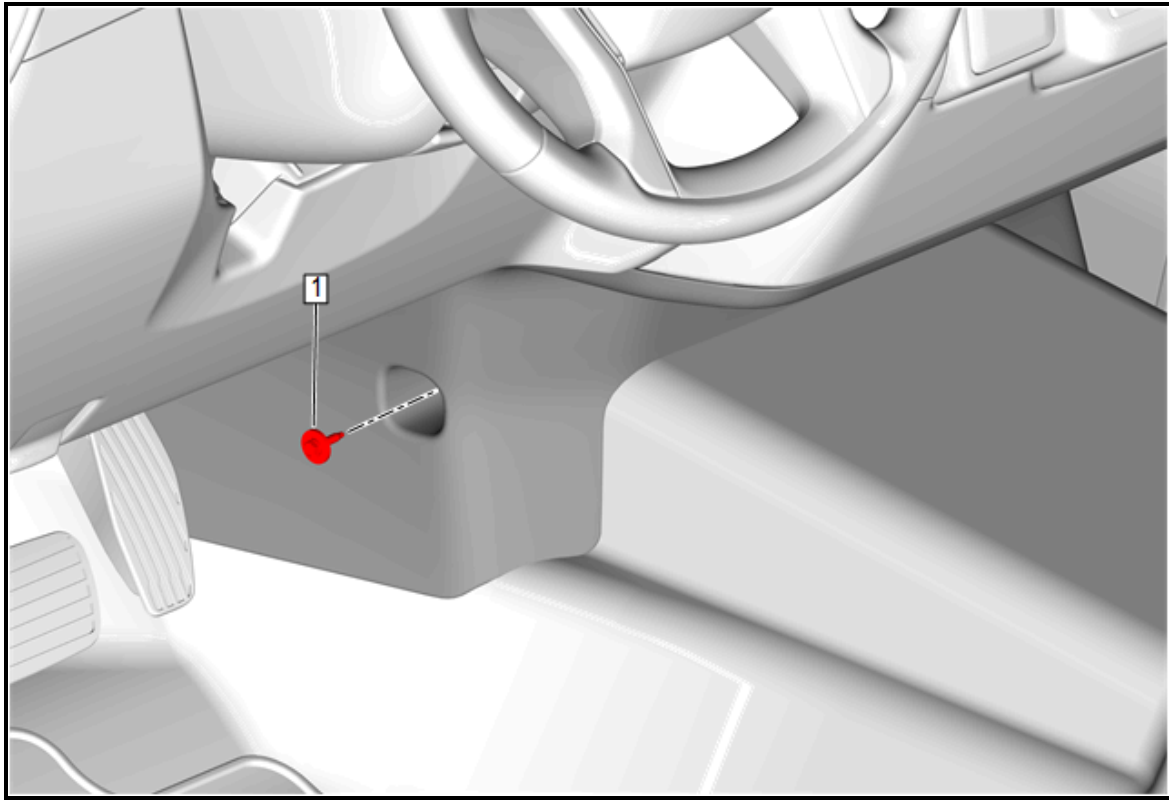

3. Instrument Panel Lower Trim Panel Bolt (1) » Remove

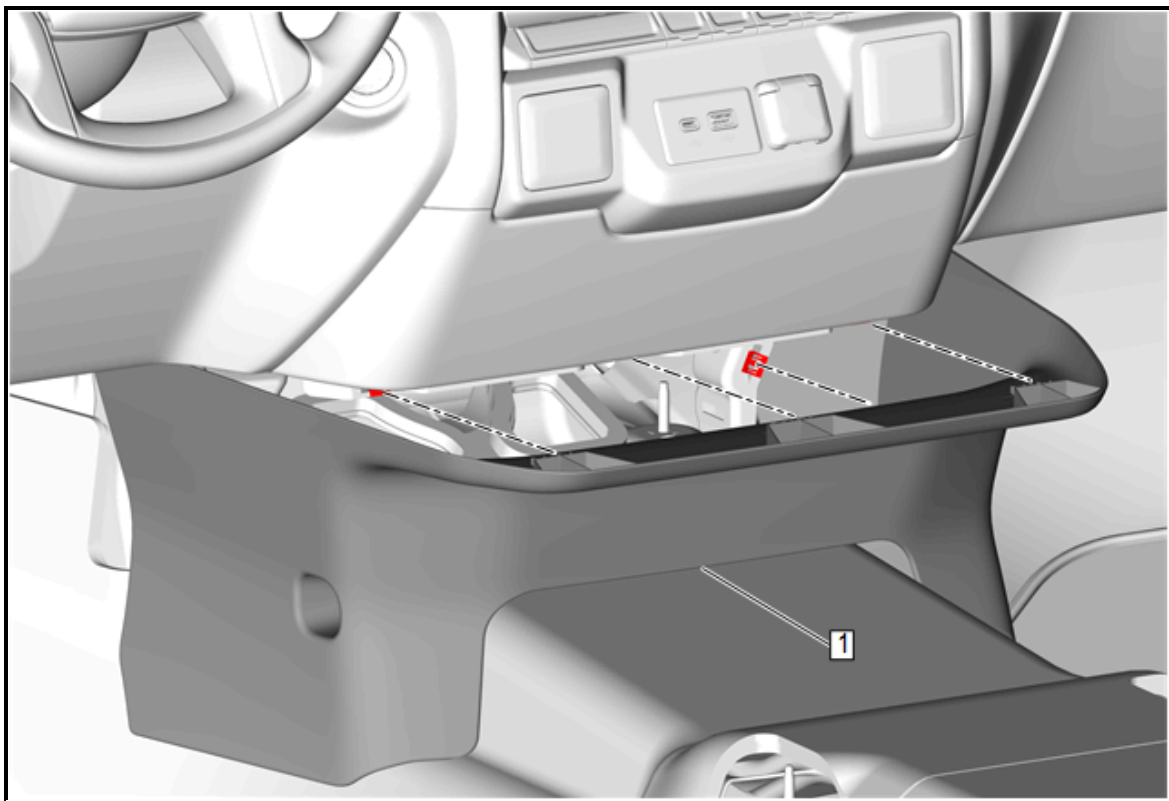

4. Instrument Panel Lower Center Trim Panel (1) » Remove

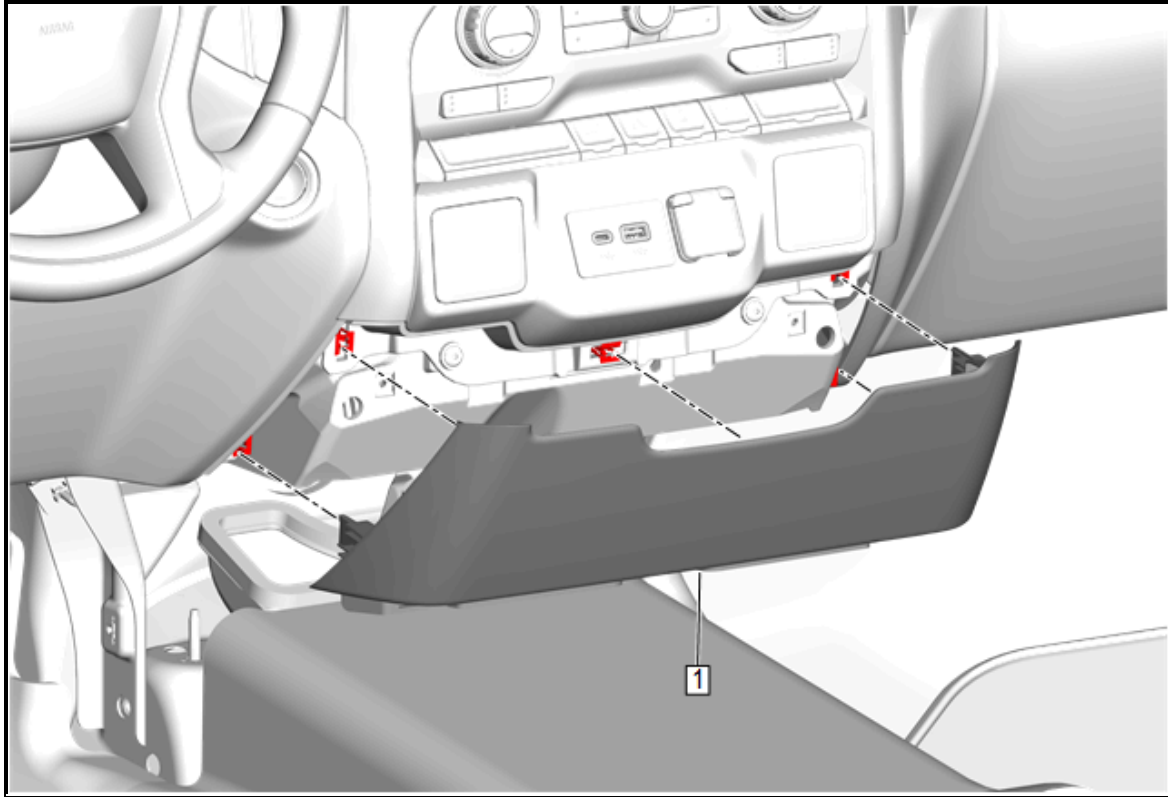

5. Using a flat-bladed plastic trim tool, release the retaining clips.

6. Instrument Panel Lower Trim Panel (1) » Remove

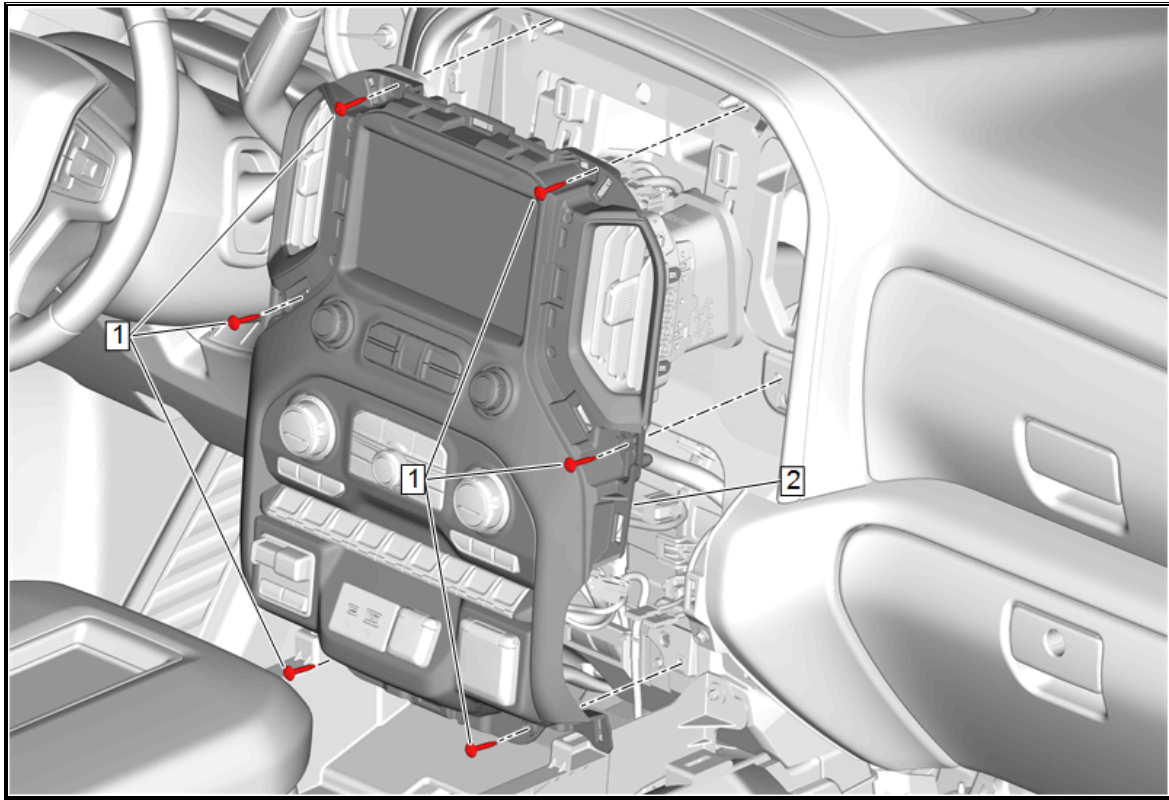

7. Radio Control Bolt (1) » Remove [6x]
8. Disconnect the electrical connectors.
9. Radio Control (2) » Remove

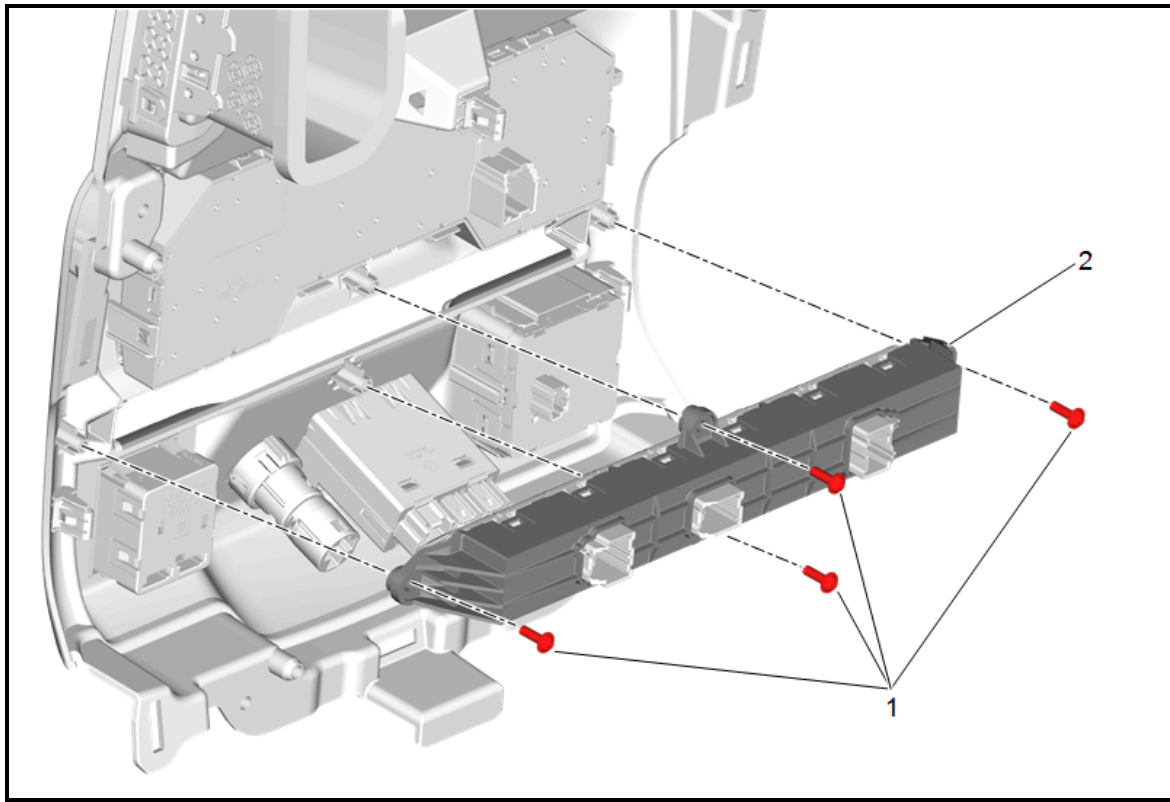

10. Hazard Warning Switch Housing Bolt (1) » Remove [4x]
11. Hazard Warning Switch Housing (2) » Remove

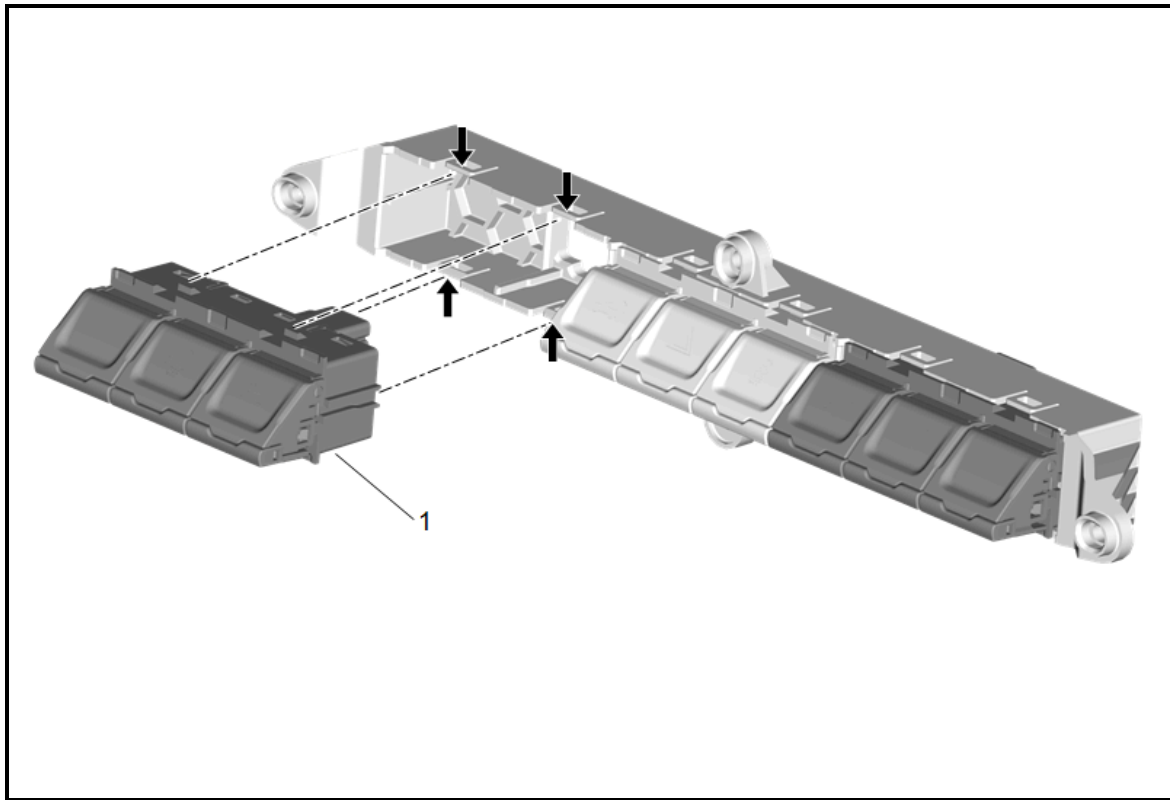

12. Release the retaining tabs.

13. Instrument Panel Center Accessory Function Switch (1) » Remove

Installation Procedure

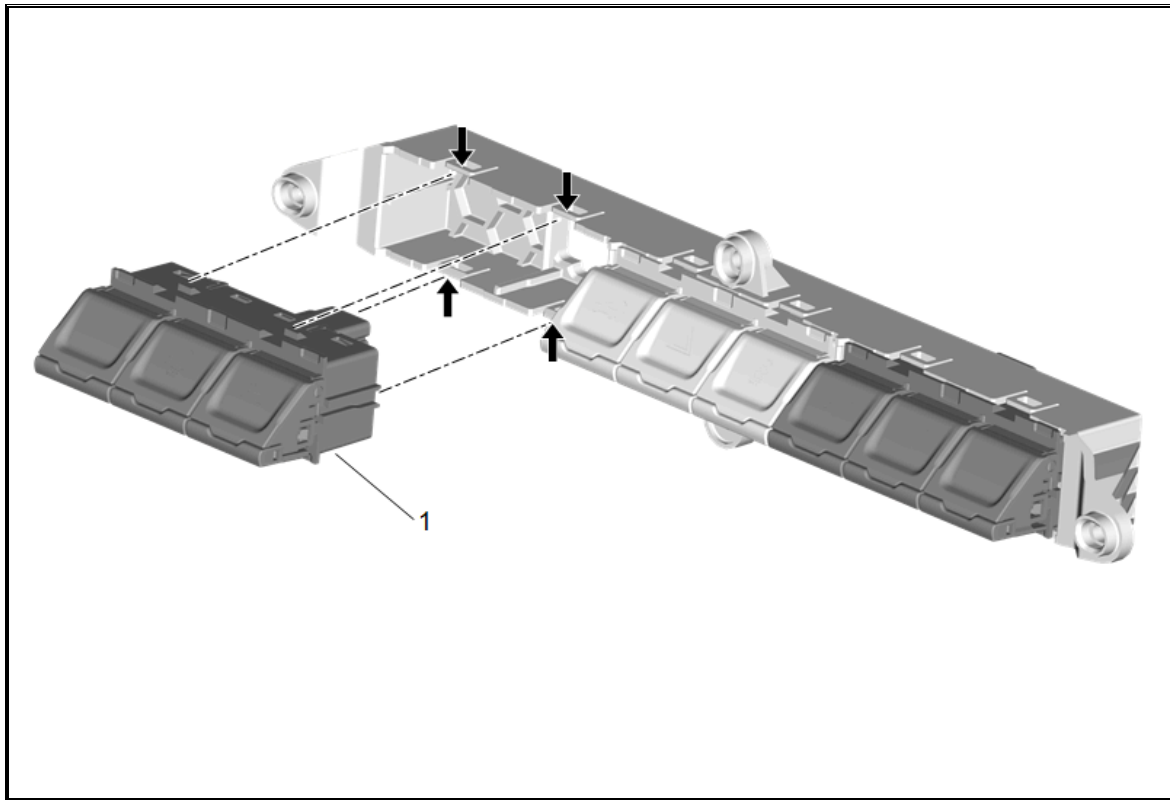

1. Instrument Panel Center Accessory Function Switch (1) » Install
2. Secure the retaining tabs.

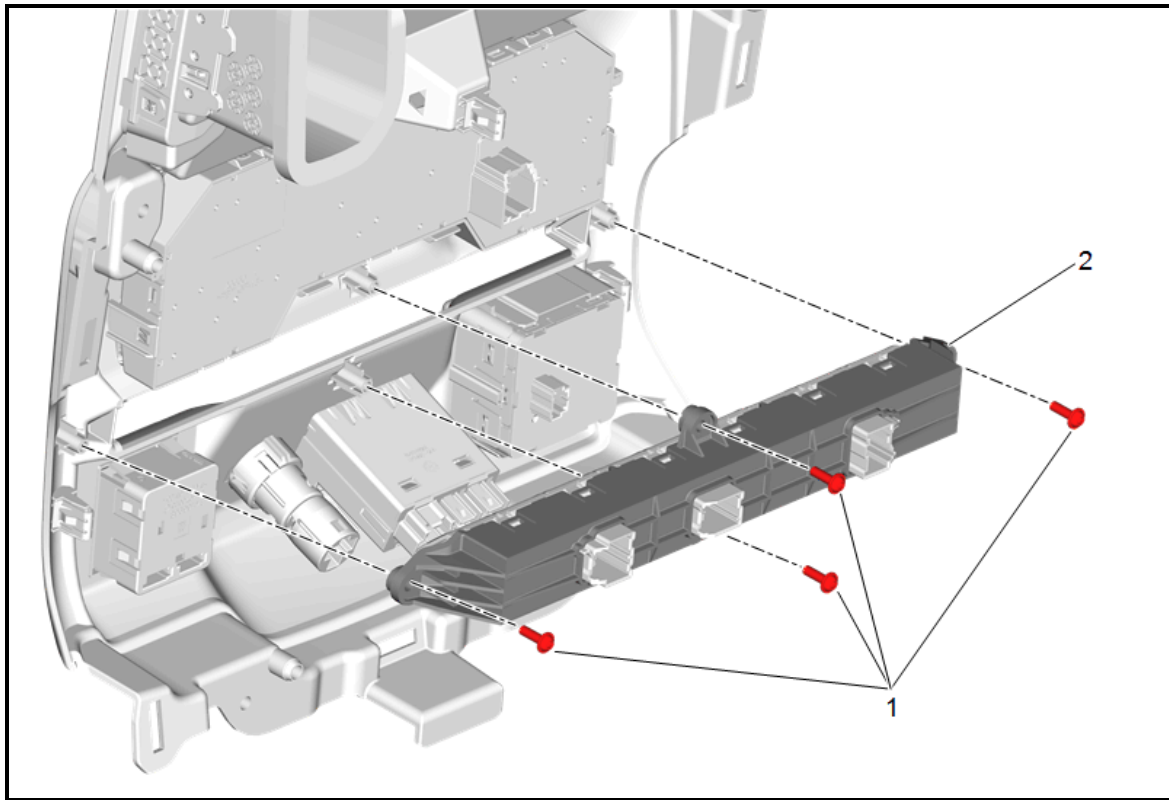

3. Hazard Warning Switch Housing (2) » Install

Caution: Refer to [Fastener Caution](#).

4. Hazard Warning Switch Housing Bolt (1) » Install and tighten [4x] — [Fastener Specifications](#)

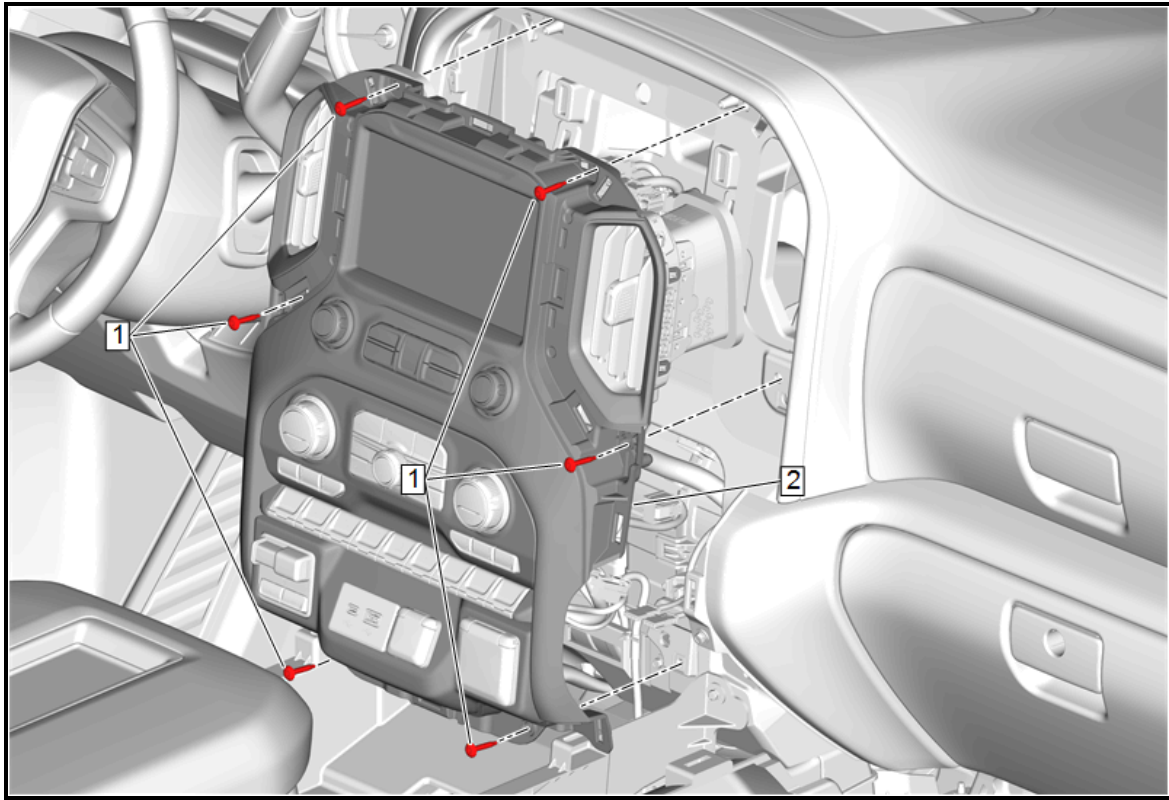

5. Connect the electrical connectors.
6. Radio Control (2) » Install
7. Radio Control Bolt (1) » Install and tighten [6x] — [Fastener Specifications](#)

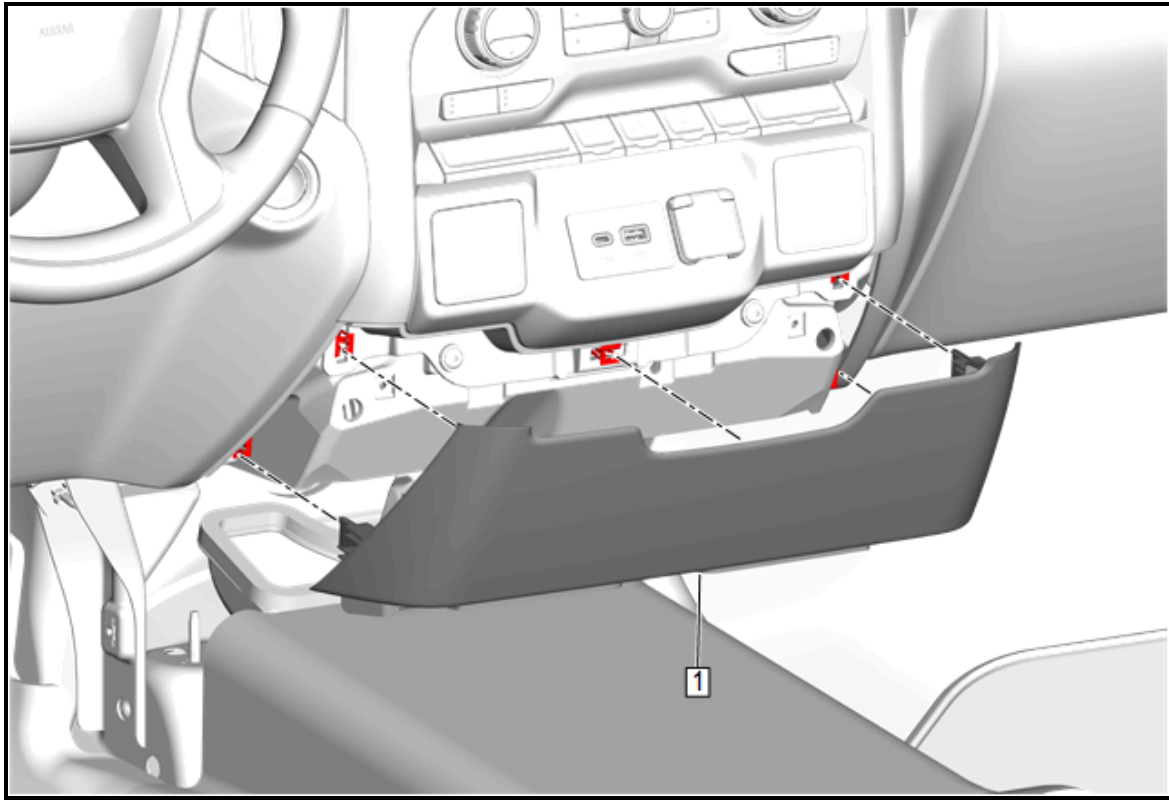

8. Instrument Panel Lower Trim Panel (1) » Install

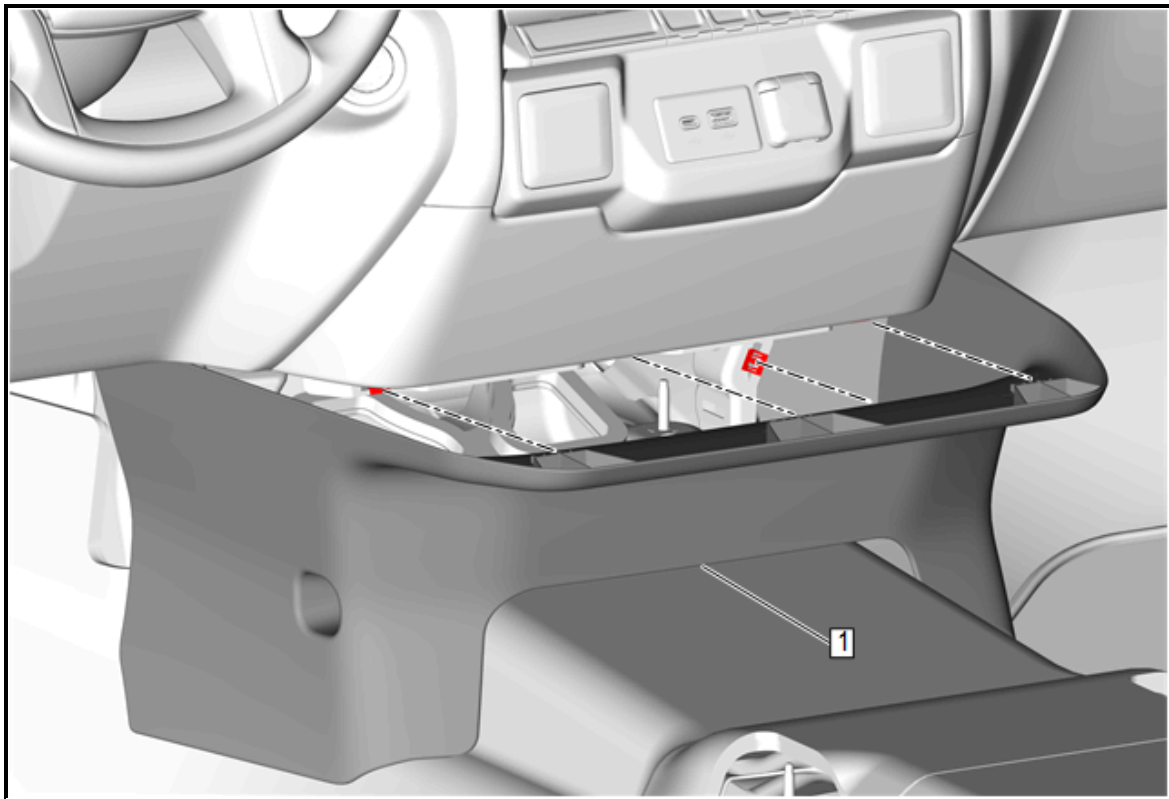

9. Instrument Panel Lower Center Trim Panel (1) » Install

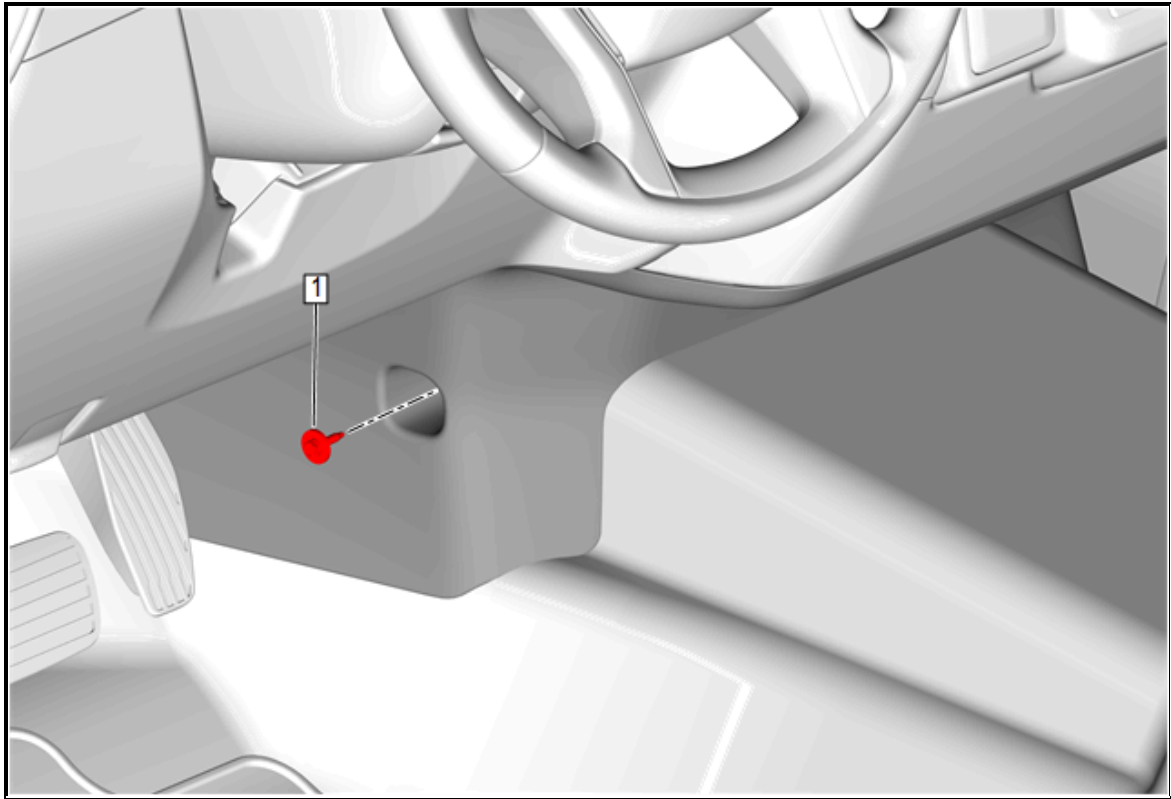

10. Instrument Panel Lower Trim Panel Bolt (1) » Install and tighten — [Fastener Specifications](#)

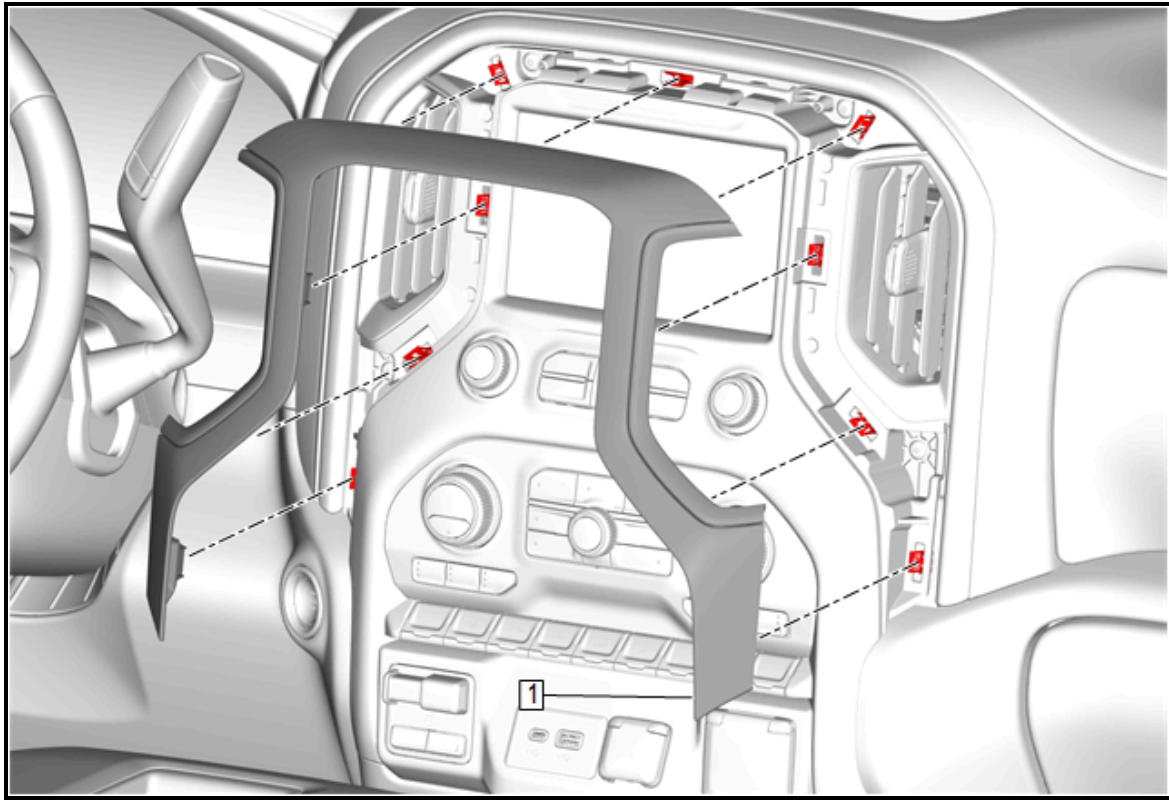

11. Instrument Panel Trim Plate (1) » Install